

08

通讯面板

COMMUNICATION PANEL

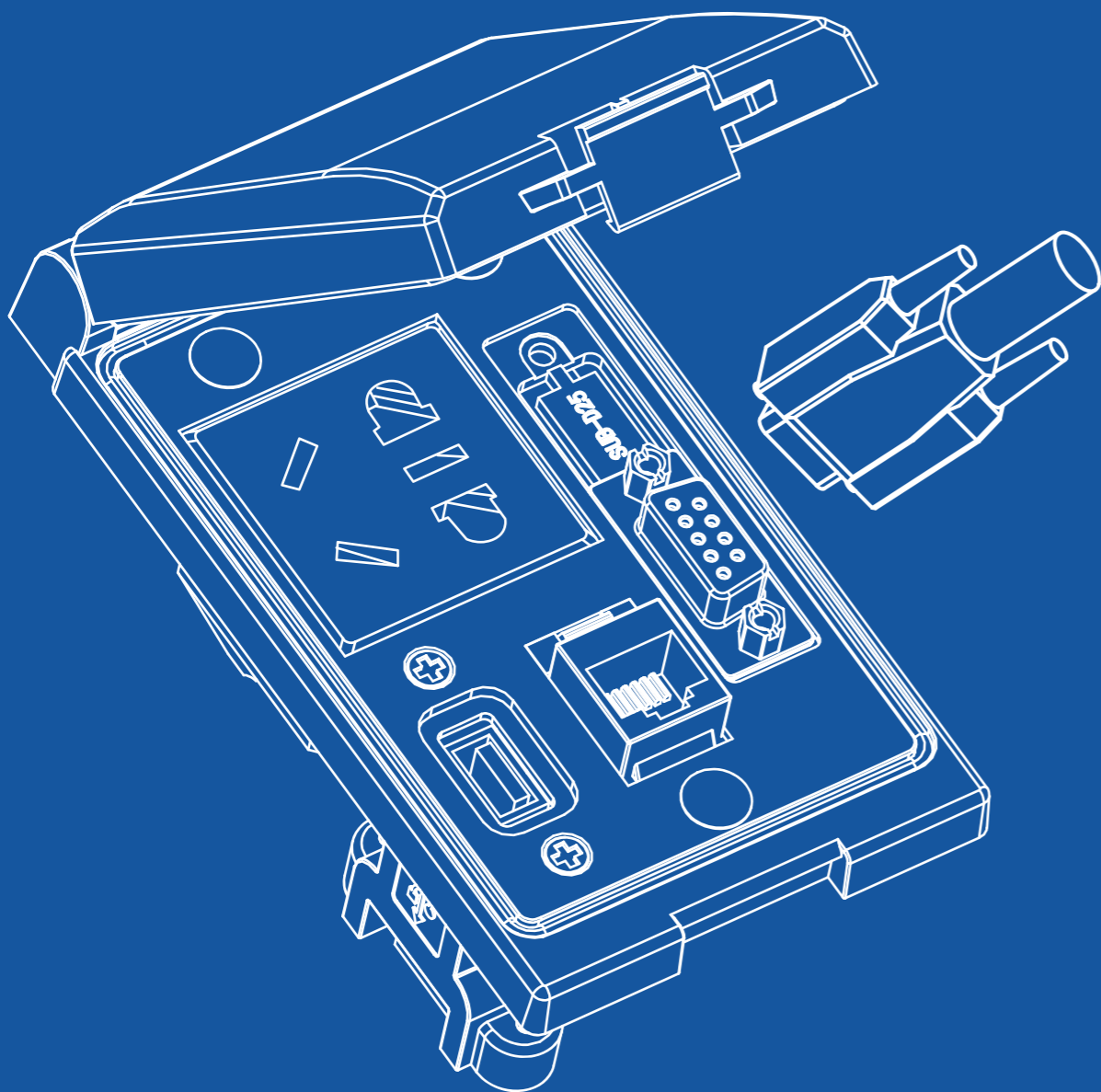

FNS[®]

COMMUNICATION PANEL

通讯面板

8.1 D-Sub连接器

8.2 RJ45&USB法兰式接口

8.3 前置调试面板

D-SUB 9/15 Pin 连接器

D-SUB 15 Pin 连接器

技术参数

额定电压	30V AC/DC
额定电流 (40°C)	2A
温度范围	- 25...+ 85 °C
压线方式	冷压压接 (冷压针见下表)

屏蔽 壳体规格: Size1G 插针180° 压线范围: 6...8.7 mm	压接/焊接	极数	订货代码	型号
	焊接式	9-pole	FMK1G-109-MS	900009
		15-pole	FMK1G-315-MS	900315
	压接式	9-pole	FMK1G-109-MC	900109

屏蔽 壳体规格: Size1G 插针180° 压线范围: 6...8.7 mm	压接/焊接	极数	订货代码	型号
	焊接式	9-pole	FMK1G-109-FS	901009
		15-pole	FMK1G-315-FS	901315
	压接式	9-pole	FMK1G-109-FC	902009

屏蔽 壳体规格: Size1 插针45° 压线范围: 6...8.7 mm	压接/焊接	极数	订货代码	型号
	焊接式	9-pole	FMK1-109-MS	910009
		15-pole	FMK1-315-MS	910315
	压接式	9-pole	FMK1-109-MC	910109

屏蔽 壳体规格: Size1 插针45° 压线范围: 6...8.7 mm	压接/焊接	极数	订货代码	型号
	焊接式	9-pole	FMK1-109-FS	911009
		15-pole	FMK1-315-FS	911315
	压接式	9-pole	FMK1-109-FC	912009

针

技术参数	线径	AWG	车针(100/包) 型号	车针(100/包) 订货号
材质: 铜镀银/金 接触电阻 ≤ 4 mΩ 接线形式: 冷压接线	0.09-0.25mm ²	AWG26-22	DAM-13	09670005576
	0.25-0.56mm ²	AWG22-20	DAM-33	09670008576
	0.09-0.25mm ²	AWG26-22	DAF-13	09670005476
	0.25-0.56mm ²	AWG22-20	DAF-33	09670008476

电路图

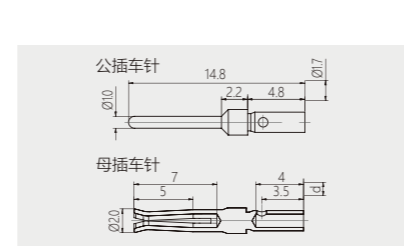
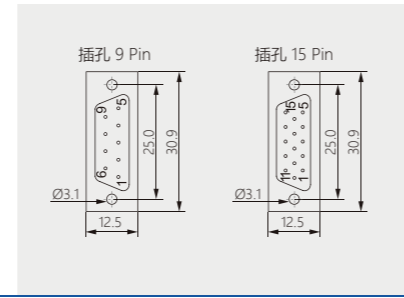
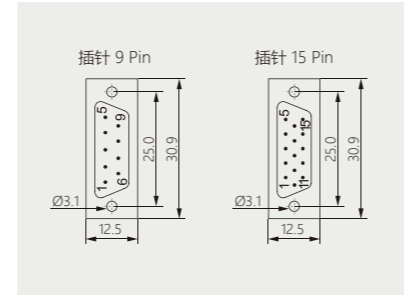
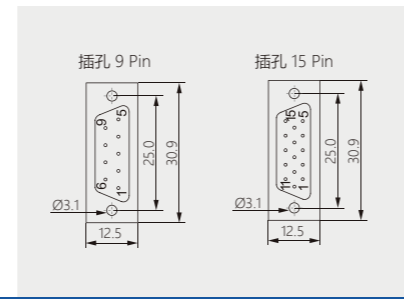
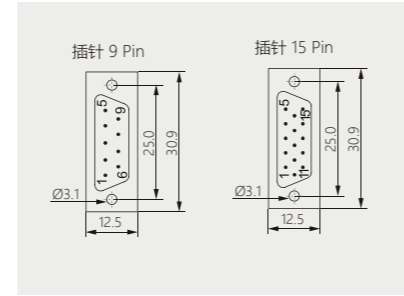

技术参数

额定电压	30V AC/DC
额定电流 (40°C)	2A
温度范围	- 25...+ 85 °C
压线方式	冷压压接 (冷压针见下表)

屏蔽 壳体规格: Size2G 插针180° 压线范围: 8...11 mm	压接/焊接	极数	订货代码	型号
	焊接式	15-pole	FMK2G-215-MS	900015
		15-pole	FMK2G-215-MC	900115

屏蔽 壳体规格: Size2G 插针180° 压线范围: 8...11 mm	压接/焊接	极数	订货代码	型号
	焊接式	15-pole	FMK2G-215-FS	901015
		15-pole	FMK2G-215-FC	902015

屏蔽 壳体规格: Size2 插针45° 压线范围: 8...11 mm	压接/焊接	极数	订货代码	型号
	焊接式	15-pole	FMK2-215-MS	910015
		15-pole	FMK2-215-MC	910115

屏蔽 壳体规格: Size1 插针45° 压线范围: 8...11 mm	压接/焊接	极数	订货代码	型号
	焊接式	15-pole	FMK2-215-FS	911015
		15-pole	FMK2-215-FC	912015

针

技术参数	线径	AWG	车针(100/包) 型号	车针(100/包) 订货号
材质: 铜镀银/金 接触电阻 ≤ 4 mΩ 接线形式: 冷压接线	0.09-0.25mm ²	AWG26-22	DAM-13	09670005576
	0.25-0.56mm ²	AWG22-20	DAM-33	09670008576
	0.09-0.25mm ²	AWG26-22	DAF-13	09670005476
	0.25-0.56mm ²	AWG22-20	DAF-33	09670008476

电路图

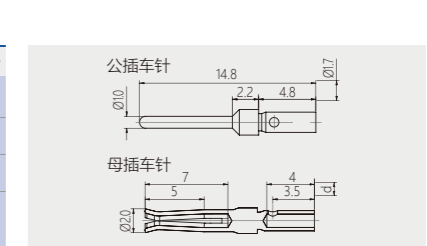
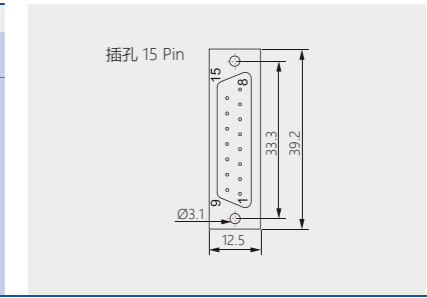
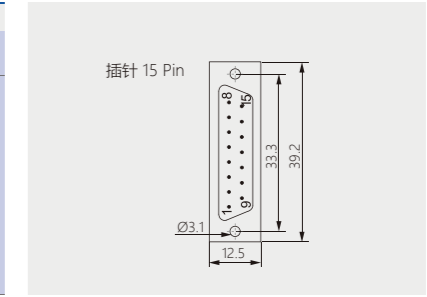
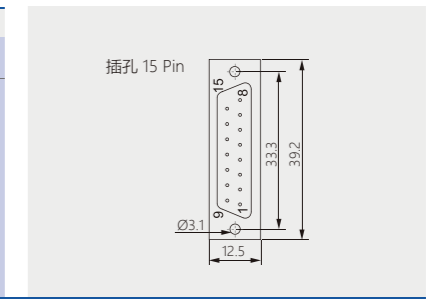
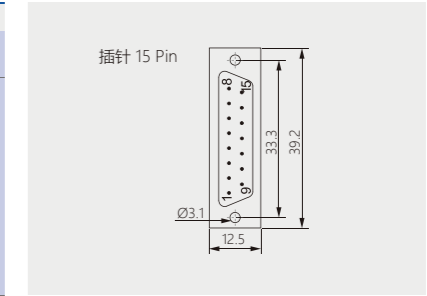

D-SUB 25Pin 连接器

技术参数

额定电压	30V AC/DC
额定电流 (40°C)	2A
温度范围	- 25...+ 85 °C
压线方式	冷压压接 (冷压针见下表)

屏蔽 壳体规格: Size3G 插针180° 压线范围: 8...11 mm	压接/焊接	极数	订货代码	型号
	焊接式	25-pole	FMK3G-225-MS	900025
	压接式	25-pole	FMK3G-225-MC	900125

屏蔽 壳体规格: Size3G 插孔180° 压线范围: 8...11 mm	压接/焊接	极数	订货代码	型号
	焊接式	25-pole	FMK3G-225-FS	901025
	压接式	25-pole	FMK3G-225-FC	902025

屏蔽 壳体规格: Size3 插针45° 压线范围: 8...11 mm	压接/焊接	极数	订货代码	型号
	焊接式	25-pole	FMK3-225-MS	910025
	压接式	25-pole	FMK3-225-MC	910125

屏蔽 壳体规格: Size3 插孔45° 压线范围: 8...11 mm	压接/焊接	极数	订货代码	型号
	焊接式	25-pole	FMK3-225-FS	911025
	压接式	25-pole	FMK3-225-FC	912025

针

技术参数	线径	AWG	车针(100/包) 型号	车针(100/包) 订货号
材质: 铜镀银/金 接触电阻 ≤ 4 mΩ 接线形式: 冷压接线	0.09-0.25mm ²	AWG26-22	DAM-13	09670005576
	0.25-0.56mm ²	AWG22-20	DAM-33	09670008576
	0.09-0.25mm ²	AWG26-22	DAF-13	09670005476
	0.25-0.56mm ²	AWG22-20	DAF-33	09670008476

电路图

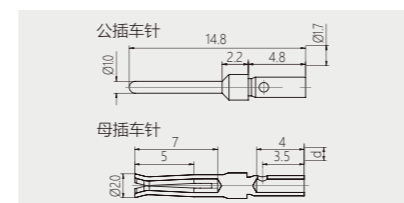
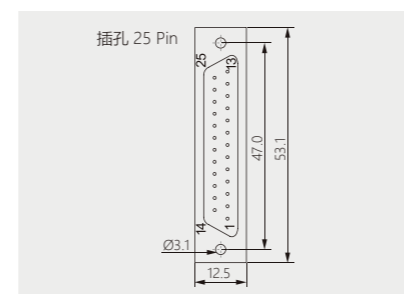
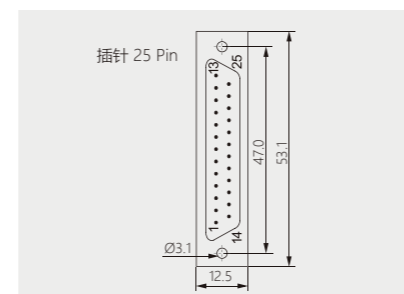
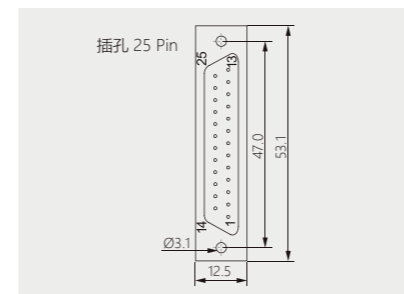
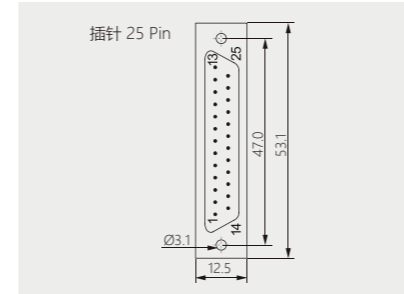

D-SUB 37Pin 连接器

技术参数

额定电压	30V AC/DC
额定电流 (40°C)	2A
温度范围	- 25...+ 85 °C
压线方式	冷压压接 (冷压针见下表)

屏蔽 壳体规格: Size4G 插针180° 压线范围: 8...11 mm	压接/焊接	极数	订货代码	型号
	焊接式	37-pole	FMK4G-237-MS	900037
	压接式	37-pole	FMK4G-237-MC	900137

屏蔽 壳体规格: Size4G 插孔180° 压线范围: 8...11 mm	压接/焊接	极数	订货代码	型号
	焊接式	37-pole	FMK4G-237-FS	901037
	压接式	37-pole	FMK4G-237-FC	902037

屏蔽 壳体规格: Size4 插针45° 压线范围: 8...11 mm	压接/焊接	极数	订货代码	型号
	焊接式	37-pole	FMK4-237-MS	910037
	压接式	37-pole	FMK4-237-MC	910137

屏蔽 壳体规格: Size4 插孔45° 压线范围: 8...11 mm	压接/焊接	极数	订货代码	型号
	焊接式	37-pole	FMK4-237-FS	911037
	压接式	37-pole	FMK4-237-FC	912037

针

技术参数	线径	AWG	车针(100/包) 型号	车针(100/包) 订货号
材质: 铜镀银/金 接触电阻 ≤ 4 mΩ 接线形式: 冷压接线	0.09-0.25mm ²	AWG26-22	DAM-13	09670005576
	0.25-0.56mm ²	AWG22-20	DAM-33	09670008576
	0.09-0.25mm ²	AWG26-22	DAF-13	09670005476
	0.25-0.56mm ²	AWG22-20	DAF-33	09670008476

电路图

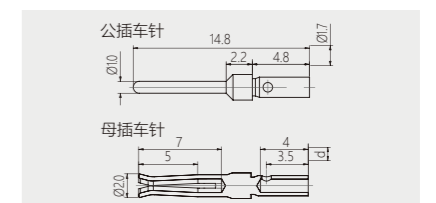
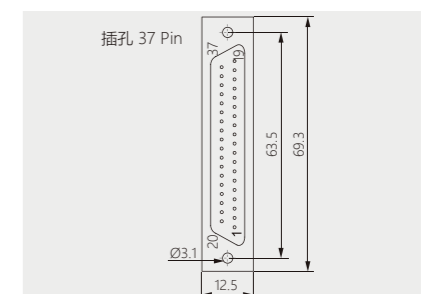
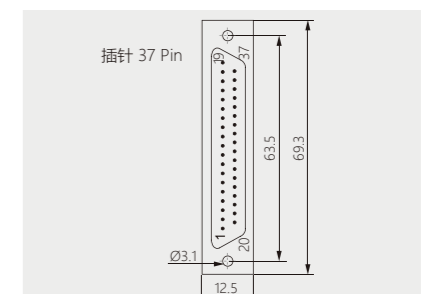
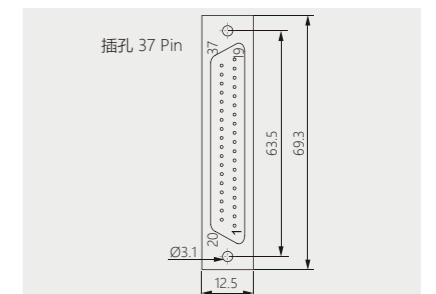
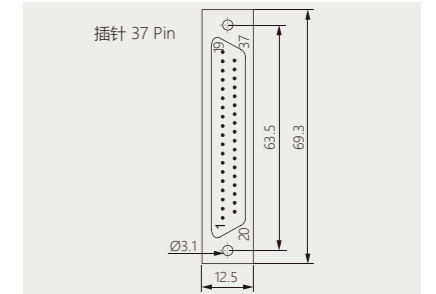

D-SUB 50Pin 连接器

技术参数

额定电压	30V AC/DC
额定电流 (40°C)	2A
温度范围	-25...+85 °C
压线方式	冷压压接 (冷压针见下表)

屏蔽 壳体规格: Size5G 插针180° 压线范围: 8...11 mm	压接/焊接	极数	订货代码	型号
	焊接式	50-pole	FMK5G-350-MS	900050
	压接式	50-pole	FMK5G-350-MC	900150

屏蔽 壳体规格: Size5G 插孔180° 压线范围: 8...11 mm	压接/焊接	极数	订货代码	型号
	焊接式	50-pole	FMK5G-350-FS	901050
	压接式	50-pole	FMK5G-350-FC	902050

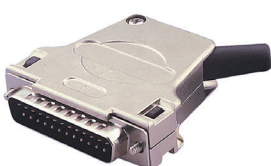
屏蔽 壳体规格: Size5 插针45° 压线范围: 8...11 mm	压接/焊接	极数	订货代码	型号
	焊接式	50-pole	FMK5-350-MS	910050
	压接式	50-pole	FMK5-350-MC	910150

屏蔽 壳体规格: Size5 插孔45° 压线范围: 8...11 mm	压接/焊接	极数	订货代码	型号
	焊接式	50-pole	FMK5-350-FS	911050
	压接式	50-pole	FMK5-350-FC	912050

针

技术参数	线径	AWG	车针(100/包) 型号	车针(100/包) 订货号
材质: 铜镀银/金	0.09-0.25mm ²	AWG26-22	DAM-13	09670005576
接触电阻 ≤ 4 mΩ	0.25-0.56mm ²	AWG22-20	DAM-33	09670008576
接线形式: 冷压接线	0.09-0.25mm ²	AWG26-22	DAF-13	09670005476
	0.25-0.56mm ²	AWG22-20	DAF-33	09670008476

电路图

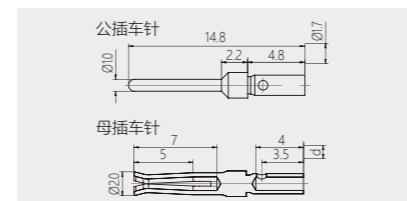
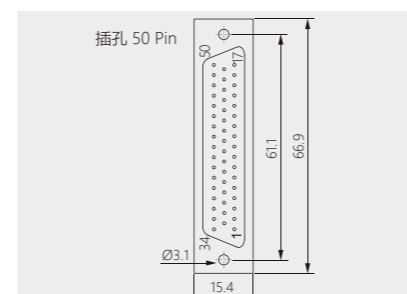
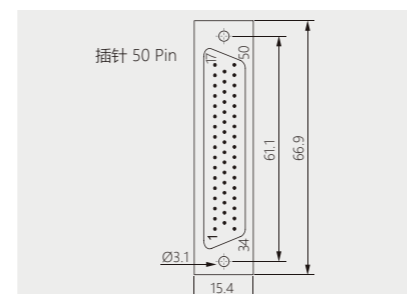
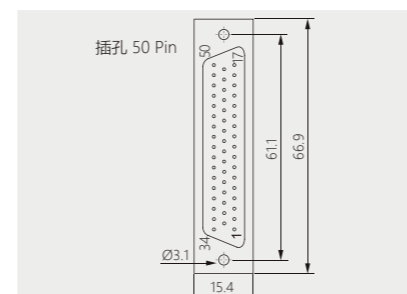
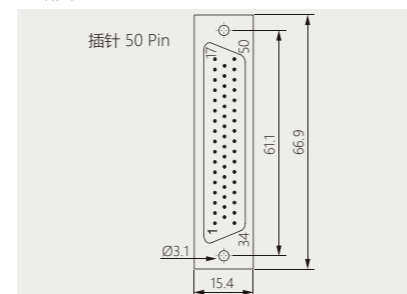

D-SUB 25 Pin 总线连接器

技术参数

额定电压	50V AC/DC
额定电流 (40°C)	1A
温度范围	-20...+75 °C
压线方式	螺钉压接

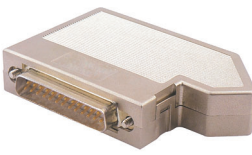
屏蔽 螺钉压接 插针45° 压线范围: 4...10 mm	极数	螺丝规格	订货代码	型号
	25-pole	M3	FMK3G-225-MP	955251
	25-pole	VC-40	FMK3G-225-MP-A	955253
	25-pole	M2.6	FMK3G-225-MP-B	955255

屏蔽 螺钉压接 插孔45° 压线范围: 4...10mm	极数	螺丝规格	订货代码	型号
	25-pole	M3	FMK3G-225-FP	955252
	25-pole	VC-40	FMK3G-225-FP-A	955254
	25-pole	M2.6	FMK3G-225-FP-B	955256

压接/焊接	极数	订货代码	型号
-------	----	------	----

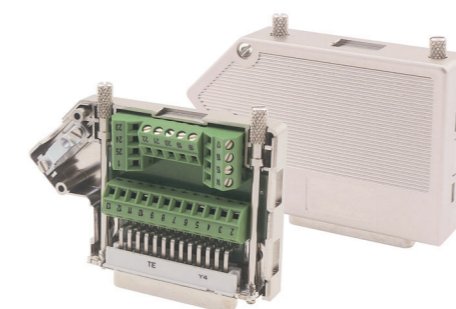

电路图

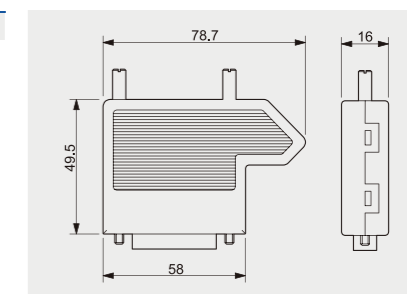
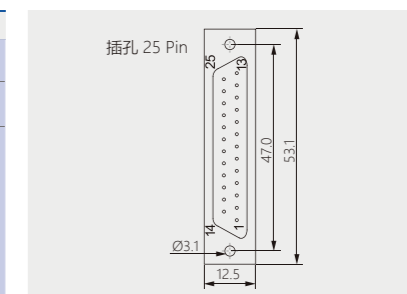
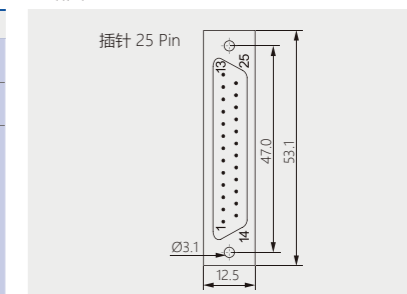

D-SUB 连接器外壳

技术参数

额定电压	锌压铸, 镀镍
温度范围	-35°C... +100°C (-67°F... +212°F)
最大锁紧力	40 Ncm (0.295 ft.lb.)

45°出线

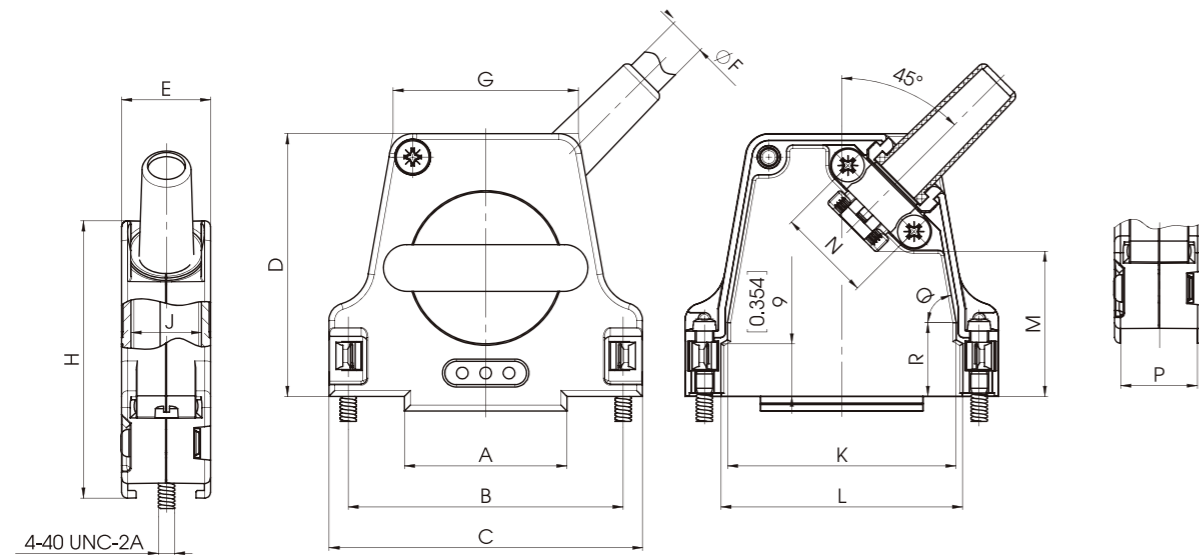

壳体规格	特征	外壳	A	B	C	D	E	F(不带橡胶套)	F(带橡胶套)	G	H	J	K	L	M	N	P	Q	R
SIZE1		1 / 9	14.9	25.0	31.6	39.5	15.2	3.0 - 9.5	6.5	20.8	42.0	12.1	17.0	19.4	23.0	12.0	13.1		
SIZE2-1		2 / 15	15.9	33.3	40.0	41.0	15.2	3.0 - 8.5	6.5	23.3	43.5	12.1	25.8	27.9	21.0	16.0	13.1	84°	
SIZE2-2	大外径	2 / 15	15.9	33.3	40.0	41.0	15.2	8.5 - 12.5	9.0	23.3	43.5	12.1	25.8	27.9	21.0	16.0	13.1	84°	
SIZE3-1		3 / 25	27.8	47.0	53.7	45.0	15.2	3.0 - 8.5	8.0	31.7	47.5	12.1	39.0	41.4	25.0	16.0	13.0	80°	12.9
SIZE3-2	大外径	3 / 25	27.8	47.0	53.7	45.0	15.2	8.5 - 12.5	9.0	31.7	47.5	12.1	39.0	41.4	25.0	16.0	13.0	80°	12.9
SIZE4-1		4 / 37	44.3	63.5	70.2	48.0	18.2	3.0 - 12.0	9.0	48.2	50.5	15.1	55.5	57.8	23.2	21.0	12.7	80°	16.1
SIZE4-2	大外径	4 / 37	44.3	63.5	70.2	48.0	18.2	12.0 - 15.0	11.5	48.2	50.5	15.1	55.5	57.8	23.2	21.0	12.7	80°	16.1
SIZE5-1		5 / 50	41.9	61.1	67.8	48.0	18.2	3.0 - 12.0	9.7	45.8	50.5	15.1	53.1	55.5	23.2	21.0	15.9	80°	16.1
SIZE5-2	大外径	5 / 50	41.9	61.1	67.8	48.0	18.2	12.0 - 15.0	11.5	45.8	50.5	15.1	53.1	55.5	23.2	21.0	15.9	80°	16.1

D-SUB 连接器外壳

技术参数

额定电压	锌压铸, 镀镍
温度范围	-35°C... +100°C (-67°F... +212°F)
最大锁紧力	40 Ncm (0.295 ft.lb.)

180°出线

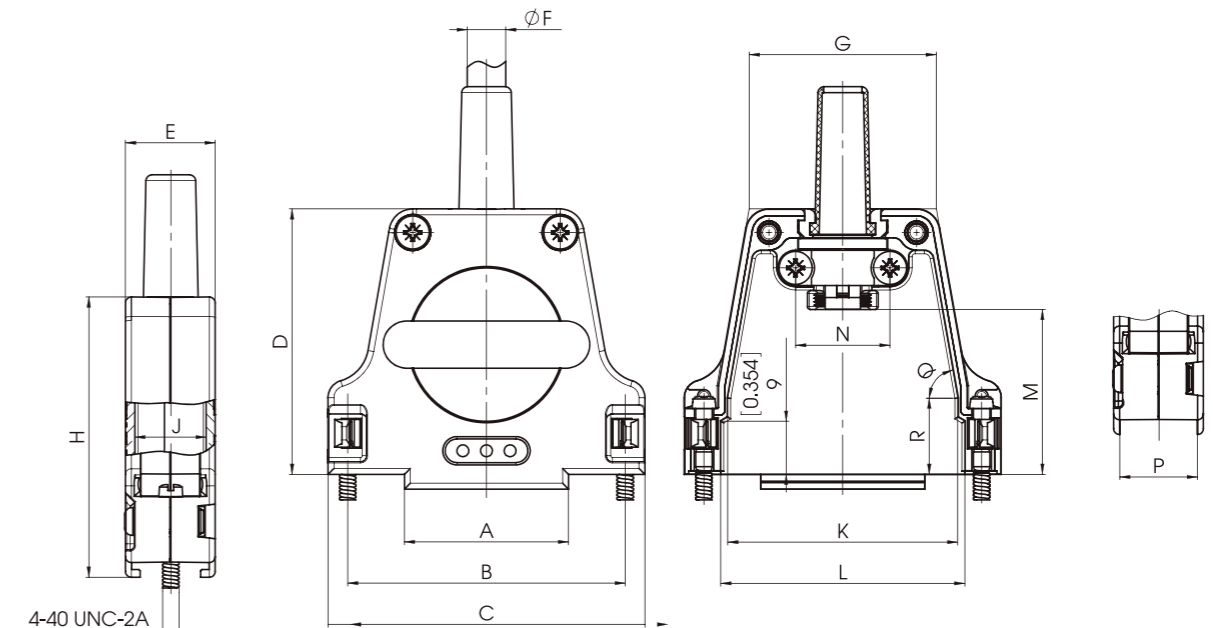

壳体规格	特征	外壳	A	B	C	D	E	F(不带橡胶套)	F(带橡胶套)	G	H	J	K	L	M	N	P	Q	R
SIZE1		1 / 9	14.9	25.0	31.6	39.5	15.2	3.0 - 9.5	6.5	20.8	42.0	12.1	17.0	19.4	23.0	12.0	13.1		
SIZE2-1		2 / 15	15.9	33.3	40.0	41.0	15.2	3.0 - 8.5	6.5	23.3	43.5	12.1	25.8	27.9	19.0	16.0	13.1	84°	
SIZE2-2	大外径	2 / 15	15.9	33.3	40.0	41.0	15.2	8.5 - 12.5	9.0	23.3	43.5	12.1	25.8	27.9	19.0	16.0	13.1	84°	
SIZE3-1		3 / 25	27.8	47.0	53.7	45.0	15.2	3.0 - 8.5	8.0	31.7	47.5	12.1	39.0	41.4	28.0	16.0	13.0	80°	12.9
SIZE3-2	大外径	3 / 25	27.8	47.0	53.7	45.0	15.2	8.5 - 12.5	9.0	31.7	47.5	12.1	39.0	41.4	28.0	16.0	13.0	80°	12.9
SIZE4-1		4 / 37	44.3	63.5	70.2	48.0	18.2	3.0 - 12.0	9.0	48.2	50.5	15.1	55.5	57.8	32.5	21.0	12.7	80°	16.1
SIZE4-2	大外径	4 / 37	44.3	63.5	70.2	48.0	18.2	12.0 - 15.0	11.5	48.2	50.5	15.1	55.5	57.8	32.5	21.0	12.7	80°	16.1
SIZE5-1		5 / 50	41.9	61.1	67.8	48.0	18.2	3.0 - 12.0	9.7	45.8	50.5	15.1	53.1	55.5	32.5	21.0	15.9	80°	16.1
SIZE5-2	大外径	5 / 50	41.9	61.1	67.8	48.0	18.2	12.0 - 15.0	11.5	45.8	50.5	15.1	53.1	55.5	32.5	21.0	15.9	80°	16.1

外型尺寸

	<table border="1"> <thead> <tr> <th>名称</th> <th>订货号</th> </tr> </thead> <tbody> <tr> <td>RJ45 面板底座 (扣手式)</td> <td>9452151103</td> </tr> </tbody> </table>	名称	订货号	RJ45 面板底座 (扣手式)	9452151103	
名称	订货号					
RJ45 面板底座 (扣手式)	9452151103					
	<table border="1"> <thead> <tr> <th>名称</th> <th>订货号</th> </tr> </thead> <tbody> <tr> <td>RJ45 面板底座 (扣手式)</td> <td>9452151108</td> </tr> </tbody> </table>	名称	订货号	RJ45 面板底座 (扣手式)	9452151108	
名称	订货号					
RJ45 面板底座 (扣手式)	9452151108					
	<table border="1"> <thead> <tr> <th>名称</th> <th>订货号</th> </tr> </thead> <tbody> <tr> <td>RJ45 4芯公插头 (扣手式)</td> <td>9451151100</td> </tr> </tbody> </table>	名称	订货号	RJ45 4芯公插头 (扣手式)	9451151100	
名称	订货号					
RJ45 4芯公插头 (扣手式)	9451151100					
	<table border="1"> <thead> <tr> <th>名称</th> <th>订货号</th> </tr> </thead> <tbody> <tr> <td>RJ45 8芯公插头 (扣手式)</td> <td>9451151108</td> </tr> </tbody> </table>	名称	订货号	RJ45 8芯公插头 (扣手式)	9451151108	
名称	订货号					
RJ45 8芯公插头 (扣手式)	9451151108					
	<table border="1"> <thead> <tr> <th>名称</th> <th>订货号</th> </tr> </thead> <tbody> <tr> <td>RJ45 直通式双网口插</td> <td>999091</td> </tr> </tbody> </table>	名称	订货号	RJ45 直通式双网口插	999091	
名称	订货号					
RJ45 直通式双网口插	999091					
	<table border="1"> <thead> <tr> <th>名称</th> <th>订货号</th> </tr> </thead> <tbody> <tr> <td>USB2.0 母座</td> <td>999101</td> </tr> </tbody> </table>	名称	订货号	USB2.0 母座	999101	
名称	订货号					
USB2.0 母座	999101					



其它信息

材质: Plastic PC + ABS 环境温度: -5...+55°C
 防尘防水等级: IP54 储存温度: -20...+60°C

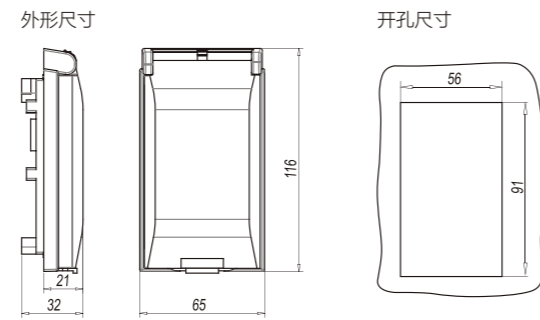

安装流程



第一步: 将 MSDD 装入切口中

第二步: 拧松螺丝



第三步: 调节螺母位置

第四步: 拧紧螺丝

选型对照图



订货号	9145209	9145209U	9145209EU
描述	国标电源插座、RJ45 网口、USB 和 D-SUB-9	万能插座、RJ45 网口、USB 和 D-SUB-9	欧标电源插座、RJ45 网口、USB 和 D-SUB-9

接口数量

订货号	型号	10A 电源插座	RJ45 网口	USB	D-SUB-9	D-SUB-15(三排)	D-SUB-25
9145209	FAS-PURD-1	1	1	1	1	/	/
9145215	FAS-PURD-2	1	1	1	/	1	/
9145225	FAS-PURD-3	1	1	1	/	/	1
9145200	FAS-PRU	1	1	1	/	/	/
9145000	FAS-PR	1	1	/	/	/	/
9100000	FAS-P	1	/	/	/	/	/
9045209	FAS-URD-1	/	2	1	1	/	/
9045215	FAS-URD-2	/	2	1	/	1	/
9045225	FAS-URD-3	/	2	1	/	/	1
9045200	FAS-RU	/	1	1	/	/	/
9045309	FAS-RUD-1	/	1	1	1	/	/
9045415	FAS-RUD-2	/	1	1	/	1	/
9045325	FAS-RUD-4	/	1	1	/	/	1



备注: 订货号后缀增加“U”, 表示通讯面板中电源插座为10A万能插座。例: 9145209U, FAS-PURD-1U
 订货号后缀增加“EU”, 表示通讯面板中电源插座为10A欧标插座。例: 9145209EU, FAS-PURD-1EU